

hugo

technical sheet

SCALE: 1/8 INCH = 1 FOOT (1:96)
 Each piece is made by hand and has its own uniqueness.
 Measures may vary with a tolerance up to 4%

STANDARD FEATURES

Hard wood frame - Reinforced and crossed
 elastic Pirelli webbing.
 Seat depth 23 inches / seat height 17 inches
 Tight arms, loose seat, cushions.
 Legs PC01/PC20 - Height 2".
 Heavy duty needle stitching on frame and cushions
 Leather thickness from 1.4 up to 2.4 mm.
 Reclining headrest.

OPTIONS

Side pocket
 Folding bed / wooden staves
 Folding bed / wire net
 Welting on back, seat, cushions stitching

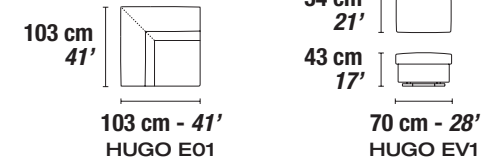
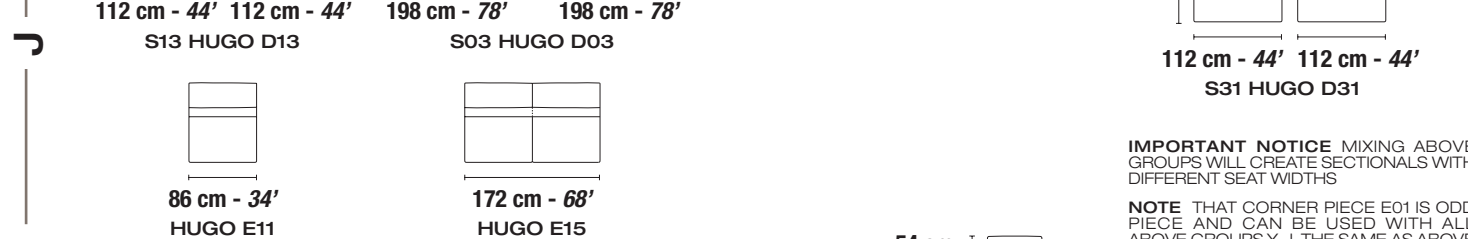
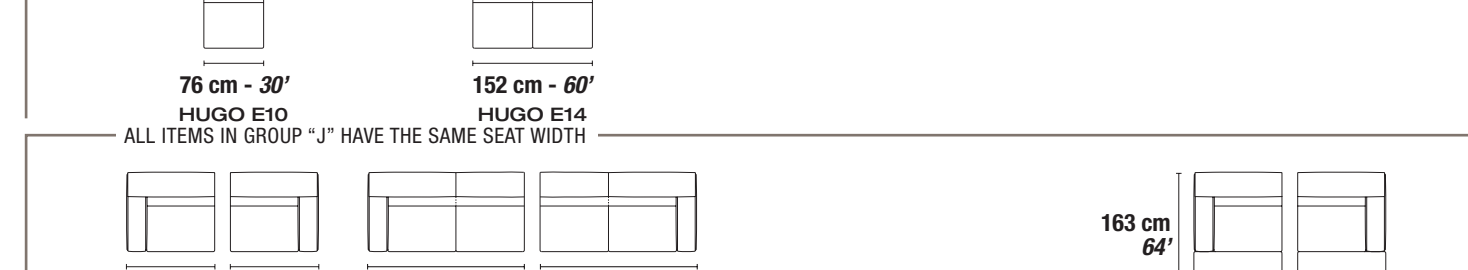
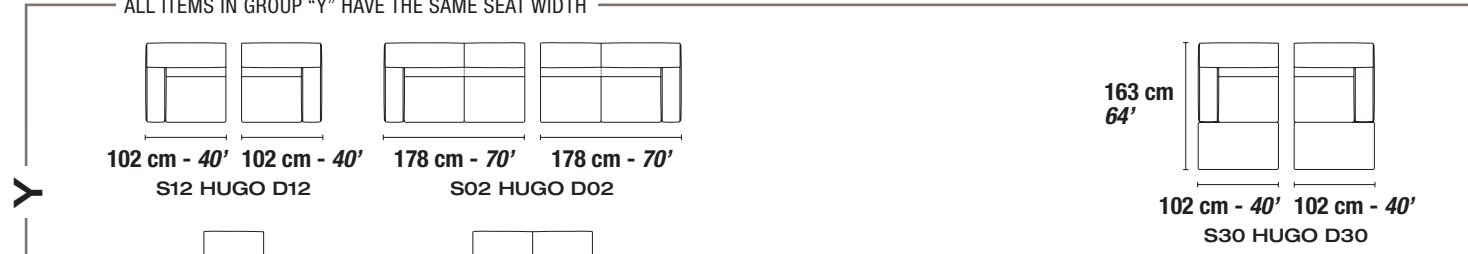
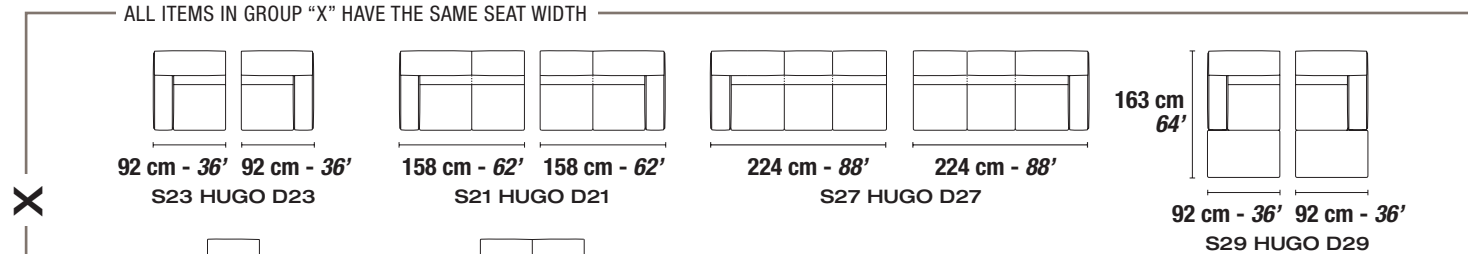
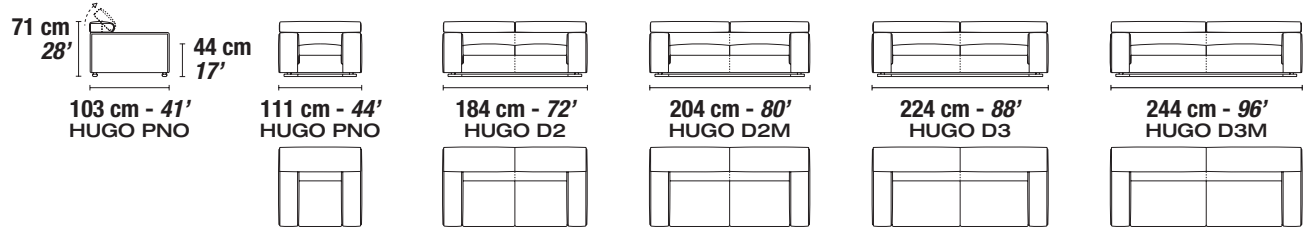
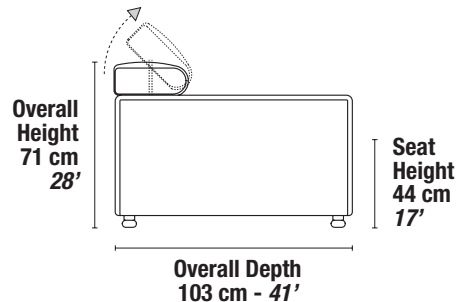

IMPORTANT NOTICE MIXING ABOVE GROUPS WILL CREATE SECTIONALS WITH DIFFERENT SEAT WIDTHS
NOTE THAT CORNER PIECE E01 IS ODD PIECE AND CAN BE USED WITH ALL ABOVE GROUPS Y, J. THE SAME AS ABOVE APPLIES TO OTTOMAN EV1.